

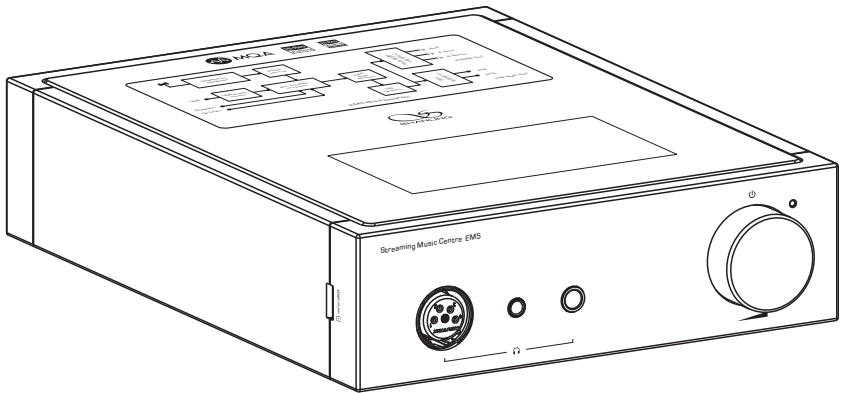

EMS

快速入门指南
Quick Start Guide



安全指示



1. 不可自行开启本机进行维修、拆卸或改造。
2. 为了充分通风，设备背面和两侧应最少保留10cm，顶部应最少保留20cm的空间。
3. 设备不应遭受水滴或水溅，机器上不应放置诸如花瓶一类的装满液体的物品。
4. 通风孔不要覆盖诸如报纸、桌布和窗帘等物品而妨碍通风。
5. 设备上不要放置裸露的火焰源，如点燃的蜡烛。
6. 设备应当连接到带保护接地连接的电网电源输出插座上。
7. 用电源插头和器具耦合器作为断开装置，断开装置应当保持能方便地操作。
8. 必须遵照电池废弃的相关地方条例来废弃旧电池。
9. 仅适用于海拔2000m以下地区安全使用，标志见图1。
10. 仅适用于非热带气候条件下安全使用，标志见图2。



图1



图2

★ 产品技术标准：GB8898-2011；GB/T13837-2012

安全注意事项



警告：谨防触电，切勿打开机盖。

等边三角形中有箭头闪电符号的图形表示警告使用者在产品内有高压电，会导致人为的触电。

等边三角形中有叹号的图形表示警告使用者该设备有重要的操作和维护指示。

部件名称

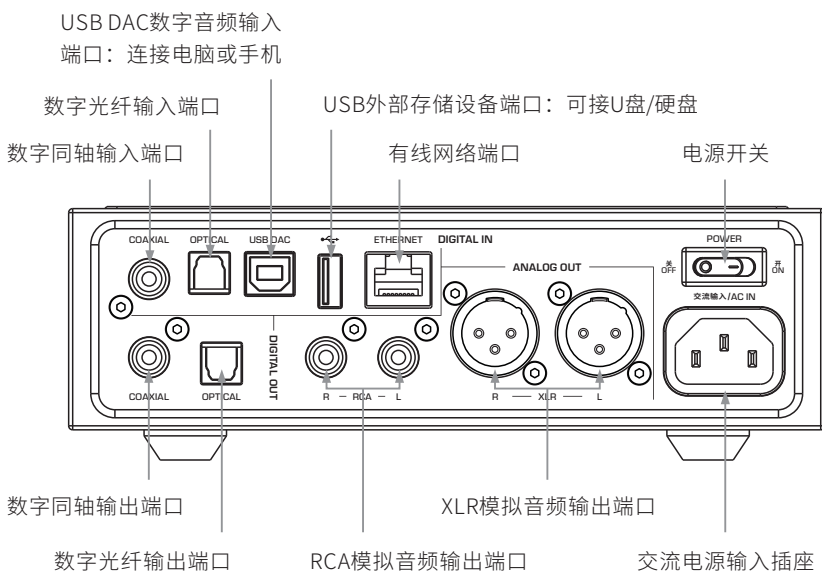
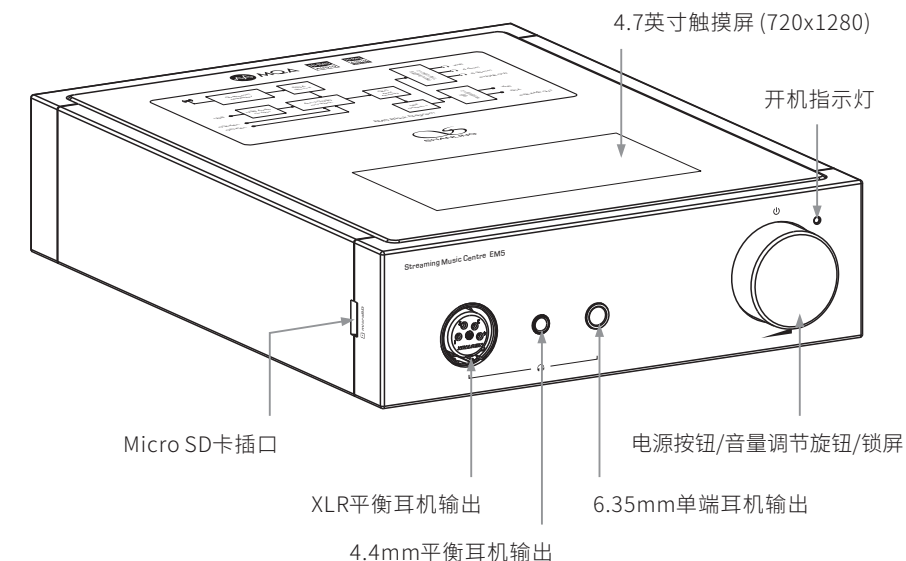

操作说明

开机/关机/锁屏

1. 开机：接通电源，将后板上的电源开关键按至 [ON/开] 位置，机器处于待机状态，面板上的待机指示灯为红色。再长按电源按钮保持2秒，状态指示变为蓝色并进入开机界面。
2. 关机：长按电源按钮2秒，显示屏显示"关机"和"重启"选择窗口，点击"关机"关闭机器。
3. 锁屏：在开机状态下，短按电源按钮进入锁屏状态，显示屏自动关闭，再按一次恢复唤醒状态，显示屏点亮。

注：若长时间不使用本机时，请将本机的交流输入电源线与市电插座分离。

手势/悬浮球操作

1. 手势模式（设置-系统设置-显示-虚拟键模式）
返回上一级：从屏幕左侧边缘向右滑或右侧边缘向左滑。
返回桌面：从屏幕下方向上滑。
2. 悬浮球模式（设置-系统设置-显示-虚拟键模式）
返回上一级：在屏幕上单击悬浮球。
返回桌面：在屏幕上长按悬浮球。

音量控制

顺时针方向旋转旋钮为增加音量，逆时针方向旋转为减小音量。

USB设置

1. 将USB线从电脑连接到机器后板上的USB DAC端口。
2. 打开机器并在主界面选择"音源切换" - "USB_DAC" 输入。
3. 连接电脑后，请将"USB驱动" 安装至电脑上。
4. 在电脑的"声音" 选项右键选择"播放设备"，并勾选"扬声器Shanling EM5" 为默认设备，如右图：

USB驱动程序下载方式：

请登录官网www.shanling.com，进入下载中心，对应产品型号进行下载。

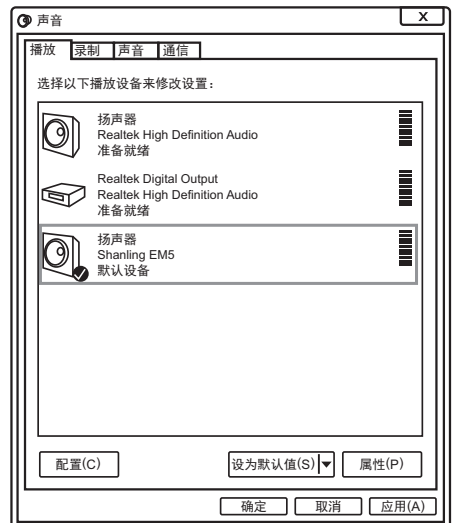

固件升级

升级过程中请不要操作机器。

OTA在线升级

1. 打开WiFi功能并连接到可用网络。
2. 前往"设置 - 固件升级 - 在线升级"即可自动检查更新。
3. 如检测到有新版本，点击"继续更新"开始下载，再点击"安装更新"直到安装完成即可。

Micro SD卡升级

1. 请在山灵官网 - 产品中心 - EM5产品页面下载固件升级程序，将新固件拷贝到机器"内置存储"或"外置存储"上，建议升级文件放置在根目录下。
2. 前往"设置 - 固件升级 - 本地升级"，进入存放固件的路径并选择相应的固件点击升级。

APP控制

扫描二维码并对应下载Eddict Player APP，安装完成后即可对产品进行操控。

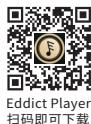

随机附件

快速入门指南：1份



保修卡：1份

三联电源线：1根

USB线：1根



3.5mm转6.35转换头：1个

Safety Instructions

1. Don't repair, disassemble or modify the device without permission.
2. For good ventilation, a minimum of 10cm clearance shall be maintained at the back and both sides and 20cm at the top of the device.
3. Avoid any exposure to liquids.
4. Do not cover any ventilation hole with newspaper, cloth, curtain, etc. otherwise it might damage the device.
5. Do not use any open flame near the device.
6. The device shall be connected to AC power output socket with grounding protection.
7. If power plug and appliance coupler are used as disconnecting device, the disconnecting device shall be easily operable.
8. Dispose of the battery in accordance with local laws.
9. Only applicable for safe use in the area with elevation under 2000m. See Fig. 1 for the sign.  
10. Only applicable for safe use under non-tropical climate conditions. See Fig. 2 for the sign. Fig. 1 Fig. 2

Safety Precautions



	Caution: Risk of electric shock. DO NOT OPEN.
	The sign with arrowed lightning inside an equilateral triangle warns the user that the player has high voltages inside which can cause electric shock.
	The sign with an exclamation mark inside an equilateral triangle warns the user that the player has important operation and maintenance instructions.

Names of Parts

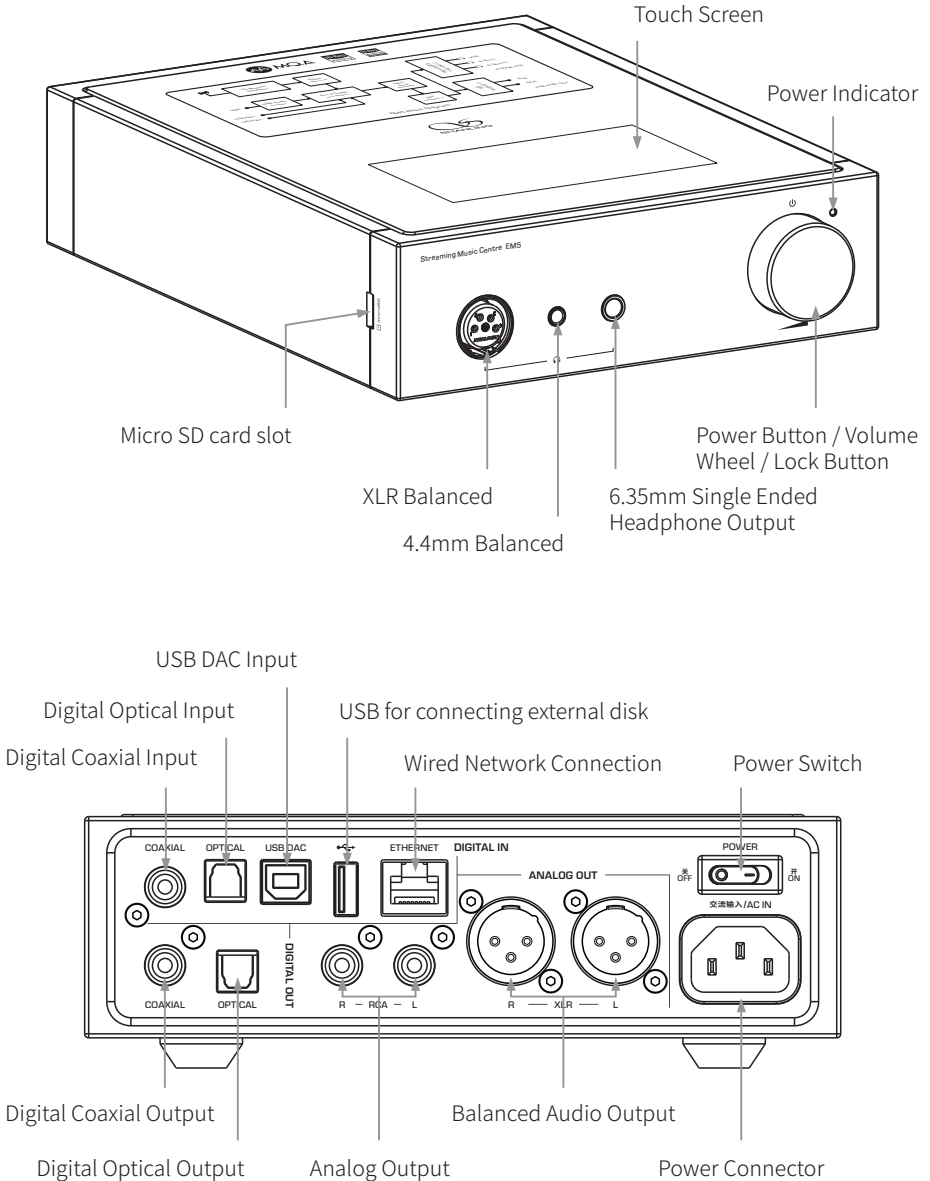

Operating instructions

Power ON / OFF / Screen Locking

1. Power on: Put the power switch to "ON" position. Then press the wheel for 2 seconds to turn on the device.
2. Power off: press and hold down the volume wheel for 2 seconds. The display shows the "Power Off" and "Restart" selection window. Click on "Power Off" to shut down the device.
3. Screen lock: while the device is powered on, short press the volume wheel to lock screen and turn off display. Press the volume wheel again to unlock device.

Note: If the device is not in use for longer period of time, please disconnect it from power outlet.

Gesture / Floating Ball Operation

1. Gesture mode (Settings - System Settings - Display - Virtual Key Mode)

Return to the previous: slide to the right from the left edge of the screen or slide to the left from the right edge of the screen.

Back to the main screen: slide up from the bottom of the screen.

2. Floating ball mode (Setting - System Settings - Display - Virtual Key Mode)

Return to the previous: click the floating ball on the screen.

Back to the desktop: press and hold the floating ball on the screen.

Volume Control

Turn the wheel clockwise to increase the volume, turn the wheel counterclockwise to decrease the volume.

USB Settings

1. Connect the EM5 to your computer, connect cable to the USB DAC input.
2. Turn on the EM5, go to Input Switching and switch to USB_DAC.
3. If connecting to a Windows computer, additional USB drivers needs to be installed. No drivers are needed for other systems.
4. After connecting the player to a computer, open "Sound" on your computer, right click on "Shanling EM5" and click "Set as Default Communication Device".

Where to download the USB driver:

Visit the EM5 product page on <http://en.shanling.com> to download the USB driver.

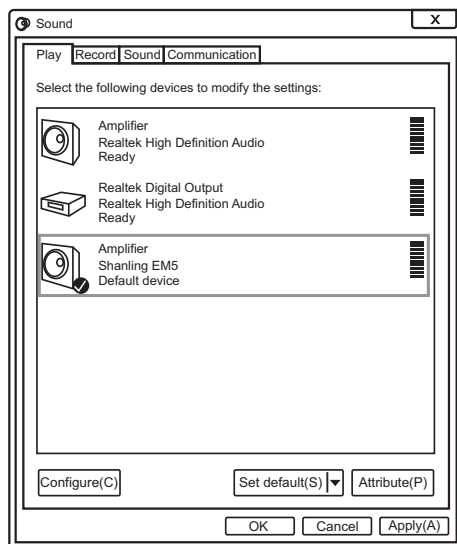

Firmware Update

Do not operate the player during the update process.

Over-the-Air Update

1. Turn on Wi-Fi and connect to local network.
2. Go to Settings – Firmware Update – Online Update.
3. Confirm installation and wait until process finishes.

Micro SD Card Update

1. Please download firmware update from Shanling's official website. Copy the latest firmware file onto the Micro SD card.
2. Go to "Settings - Firmware Update - Local Update", choose the path to firmware file and click update.

Companion APP

Eddict Player app allows access to additional settings and control over EM5. You can download it from Play store or Apple Store.

Attached Accessories

Quick start guide: 1

Warranty card: 1

Power cable: 1

USB cable: 1

3.5mm to 6.35mm Adapter: 1



MQA (Master Quality Authenticated)

EM5 includes MQA technology, which enables you to play back MQA audio files and streams, delivering the sound of the original master recording.

The EM5 Now Playing status glows green or blue dot next to MQA logo to indicate that the unit is decoding and playing an MQA stream or file, and denotes provenance to ensure that the sound is identical to that of the source material. It shows blue to indicate it is playing an MQA Studio file, which has either been approved in the studio by the artist/producer or has been verified by the copyright owner.

MQA and the Sound Wave Device are registered trade marks of MQA Limited © 2016



微信公众号



微博公众号

公司名称: 深圳山灵数码科技发展有限公司

Company: Shenzhen Shanling Digital Technology Development Co.,Ltd.

公司地址: 深圳市南山区蛇口赤湾一路10号

Address: No.10, Chiwan 1 Road, Shekou Nanshan District of Shenzhen City, China.

QQ群/QQ Group: 667914815; 303983891; 554058348

服务热线/Telephone: 400-630-6778

电子邮件/E-mail: info@shanling.com

官网/Official Website: www.shanling.com

工作时间(周一至周五): 08:00-12:00; 13:30-17:30

由于产品不断改进,各项规格及设计随时更改,恕不另行通知。

Due to continuous improvement, every specification and design is subject to change at any time without further notice.